

VCM1604

TECHNICAL DATA SHEET

PANEL MOUNT COUPLING BODY (NON VALVED)

Part #: **VCM1604**

Connection Type: Hose Barb

Material: Brass

Material Finish: Chrome Plated

Pressure Range: Vacuum to 250 psi, 17.3 bar

Temp. Range: -40°F to 180°F (-40°C to 82°C)

Mounting Option: Panel Mount

Size: 1/4" ID (6.4mm ID)

Valve Option: Non-Valve

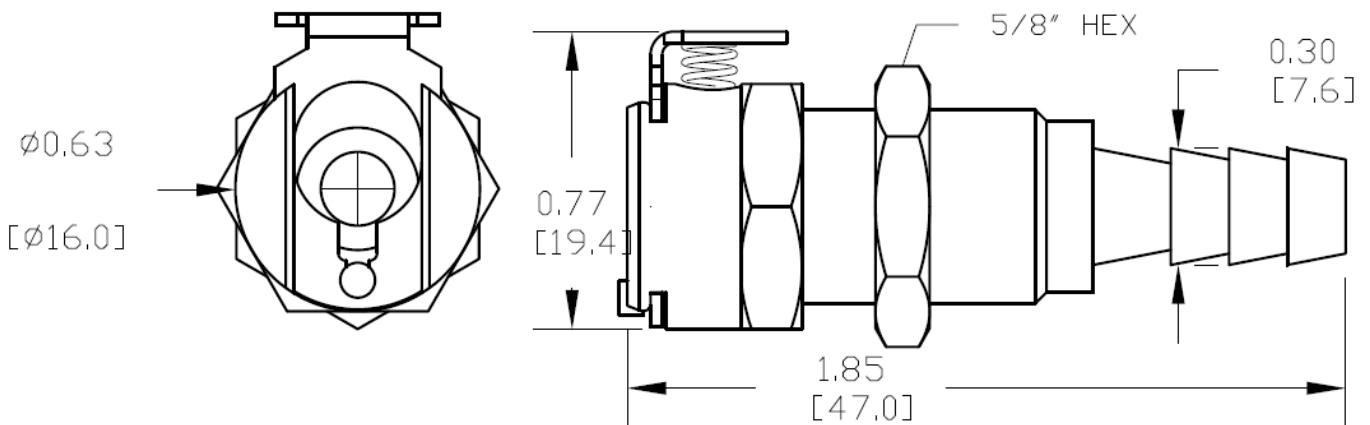

Components:

Main Body: Chrome Plated Brass

Thumb Latch: Stainless Steel

External Spring: Stainless Steel